

AI / ML / Deep Learning



David Menotti

www.inf.ufpr.br/menotti/am-191

Objetivos

- *Deep Learning - Breakthroughs*
 - Histórico e eventos

Deep Learning

- ***Deep Learning*** é como sexo na adolescência.
 - Todo mundo fala sobre
 - Ninguém realmente sabe como fazer
 - Todo mundo pensa que todo mundo está fazendo
 - Então, todo mundo diz que está fazendo

Deep Learning

- Fatores que influenciam
 - Desenvolvimento de Algoritmos
 - Hardware capaz de processar grandes massas de dados (GPU)
 - Disponibilidade de dados anotados
 - Imagens no Facebook
 - Voz e Texto no Google

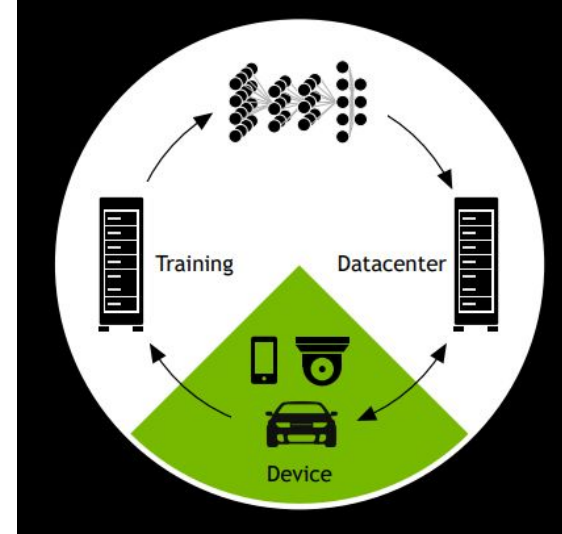

Tradicional x Deep Learning

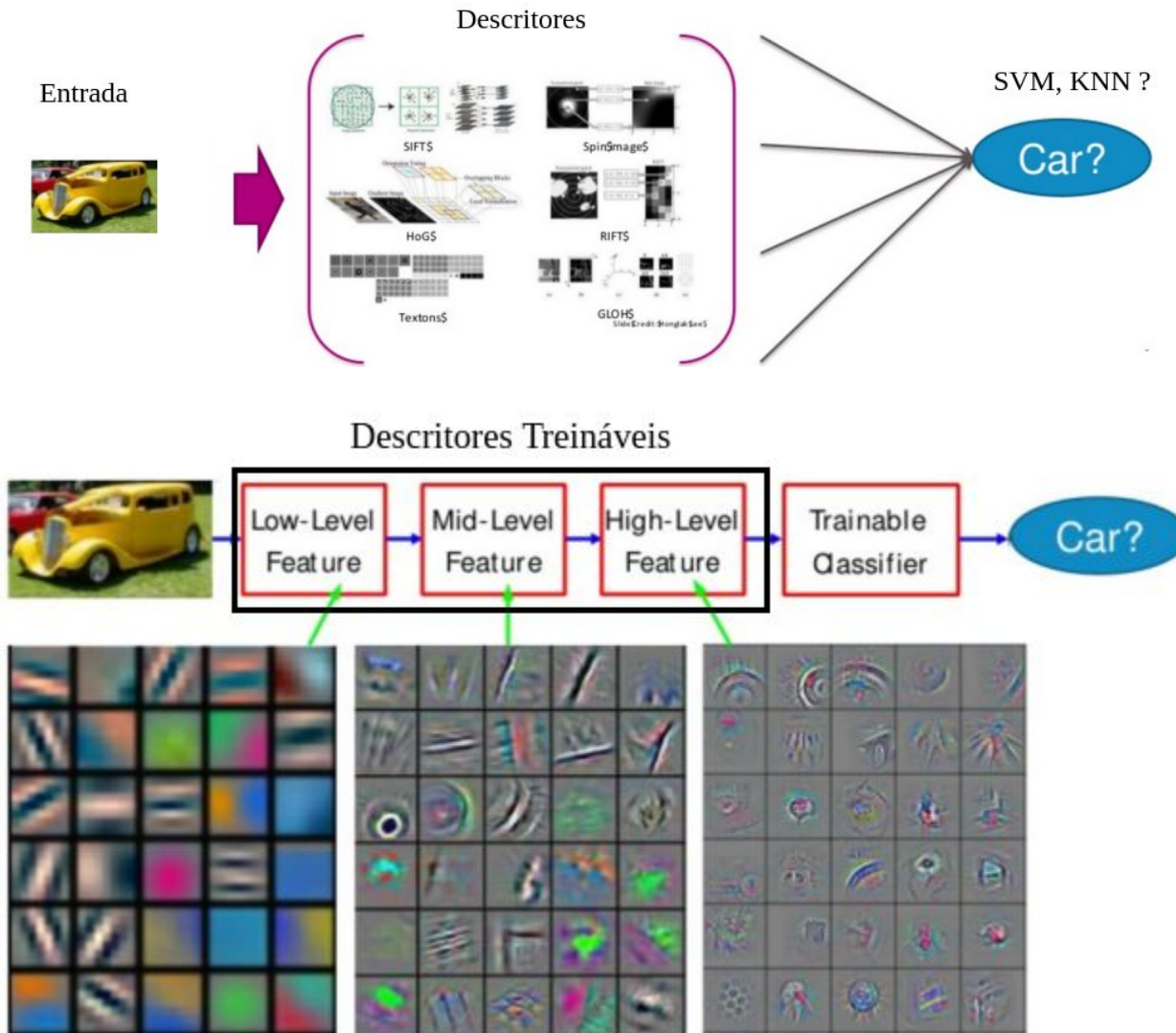

Convolução

- Chave em *Deep Learning*
 - Pesos compartilhados

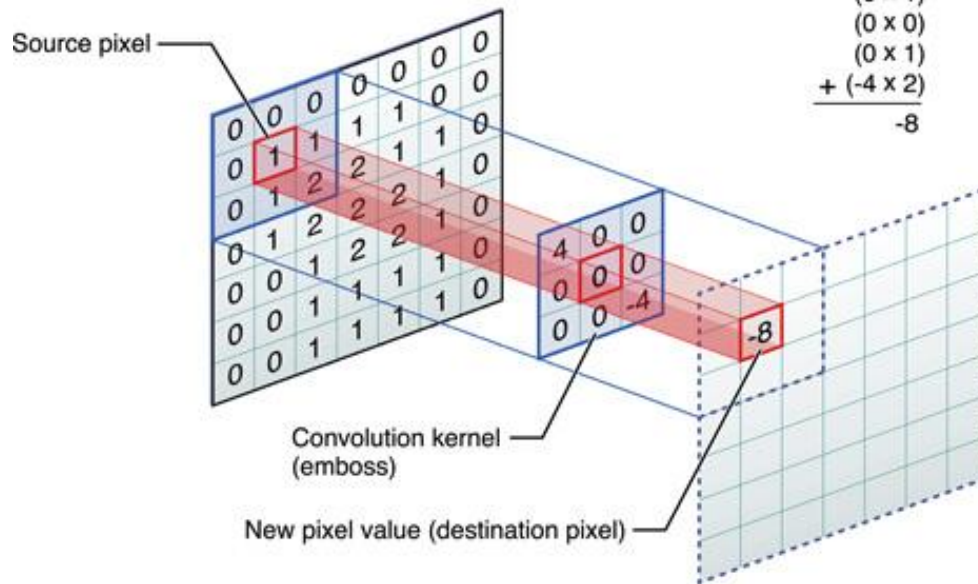

$$\begin{array}{r}
 (4 \times 0) \\
 (0 \times 0) \\
 (0 \times 0) \\
 (0 \times 0) \\
 (0 \times 1) \\
 (0 \times 1) \\
 (0 \times 0) \\
 (0 \times 1) \\
 + (-4 \times 2) \\
 \hline
 -8
 \end{array}$$

1 _{x1}	1 _{x0}	1 _{x1}	0	0
0 _{x0}	1 _{x1}	1 _{x0}	1	0
0 _{x1}	0 _{x0}	1 _{x1}	1	1
0	0	1	1	0
0	1	1	0	0

Image

4		

Convolved Feature

Pooling

- Largamente utilizado
 - Reduz **dim.** representação

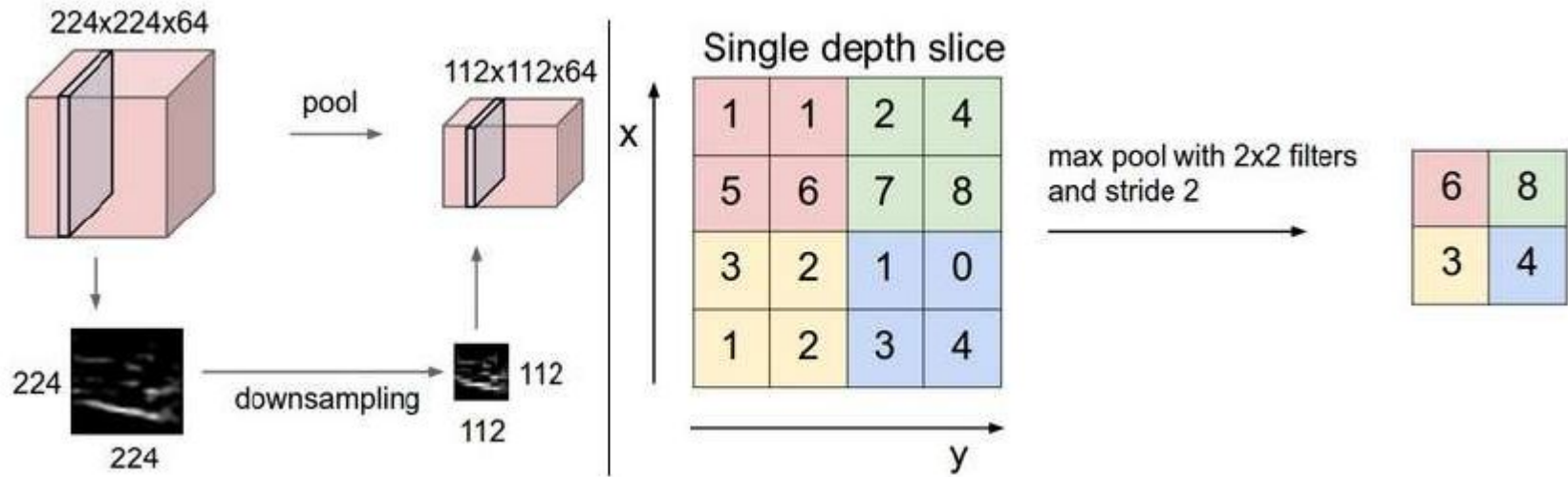

Funções de ativação

- ReLU elimina o problema do **vanish gradient**

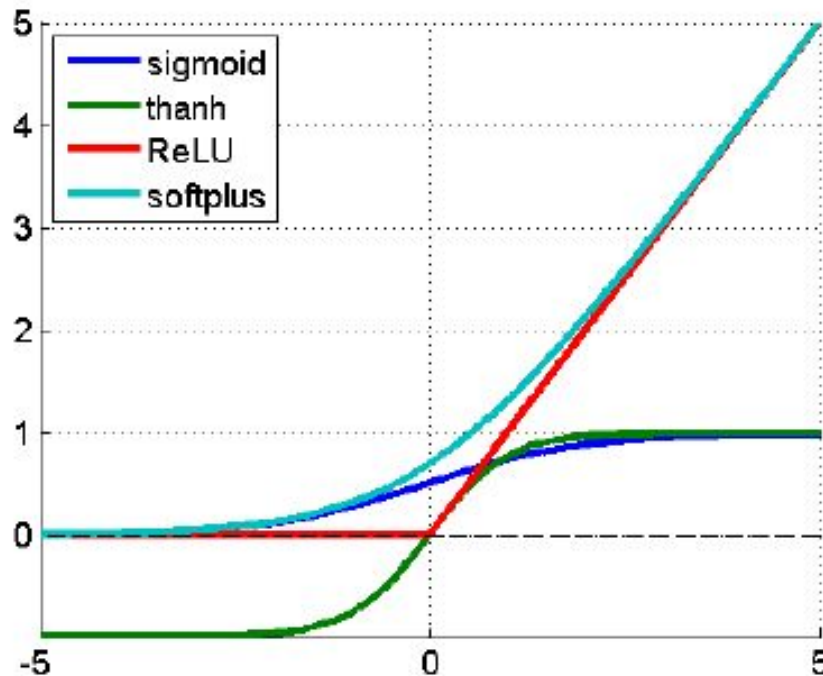

$$f(x) = \max(0, x)$$

$$f'(x) = \begin{cases} 1, & x \geq 0 \\ 0, & x < 0 \end{cases}$$

- Yoshua **Bengio**, Ian Goodfellow and Aaron Courville. Deep Learning. MIT Press. <http://www-labs.iro.umontreal.ca/~bengioy/DLbook> (citado por 3467 jul/2018)

LeNet (Lecun)

- 1998 - 1a. CNN implementada com sucesso (Bell Labs)
 - Reconhecimento de Dígitos Manuscritos
 - Imagem de entrada de **32x32 pixels**
 - MNIST Dataset (10 classes [0-9])
 - #60k *train* / #10k *test*
 - 0,95% / ~345 k conexões ~60k parâmetros

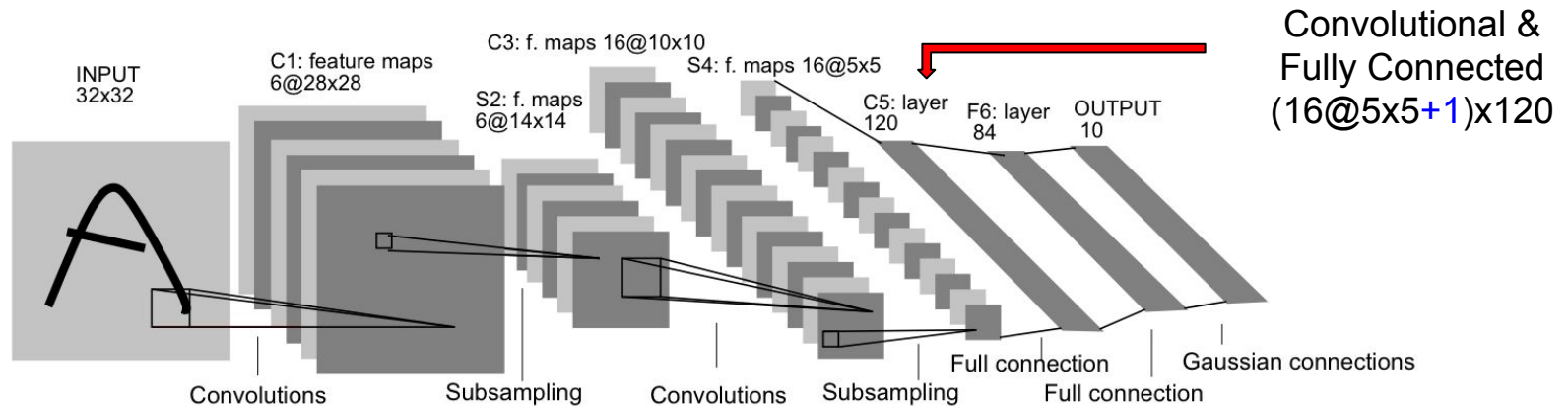

- Y. **LeCun**, L. Bottou, Y. **Bengio** & Patrick Haner, Gradient Based Learning Applied to Document Recognition, Proc. of IEEE, 1998

LeNet (Lecun)

- Arquitectura

- Pesos & Bias (340.908 / 60.000)

-

- C1: conv: 6@5x5 => 122.304 (6x(5x5+1)=156) => 6@28x28
 - S2: pool: 2x2 => 5.880 (6x2=12) => 6@14x14
 - C3: conv: *@5x5 => 151.600 ((*60x5x5)+16=1.516) => 16@10x10
 - S3: pool: 2x2 => 2.000 (16x2=32) => 16@5x5
 - C5: fully: 16@5x5 => 48.120 (16x5x5+1)x120 => 120
 - F6: fully: 120x84 => 10.164 (84x(120+1)) => 84**
 - => 60.000 total

- Out: fully: 84x10

Camada C3

	0	1	2	3	4	5	6	7	8	9	10	11	12	13	14	15
0	X				X	X	X			X	X	X	X		X	X
1	X	X				X	X	X			X	X	X	X		X
2	X	X	X				X	X	X			X		X	X	X
3		X	X	X			X	X	X	X			X	X	X	X
4			X	X	X			X	X	X	X		X	X	X	X
5				X	X	X			X	X	X	X		X	X	X

Camada F6



LeNet - Funcionamento

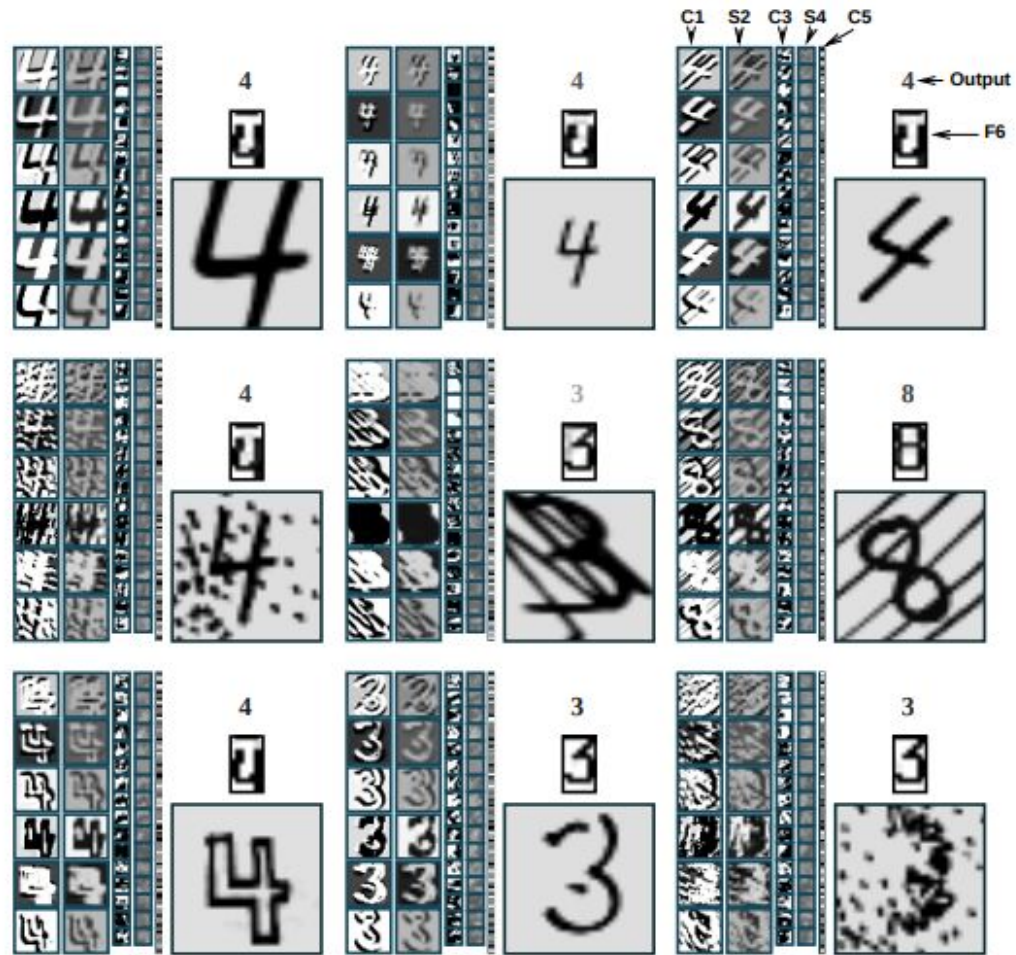

Robusto a ruídos, inclinação e forma

LeNet vs *State of the Art*

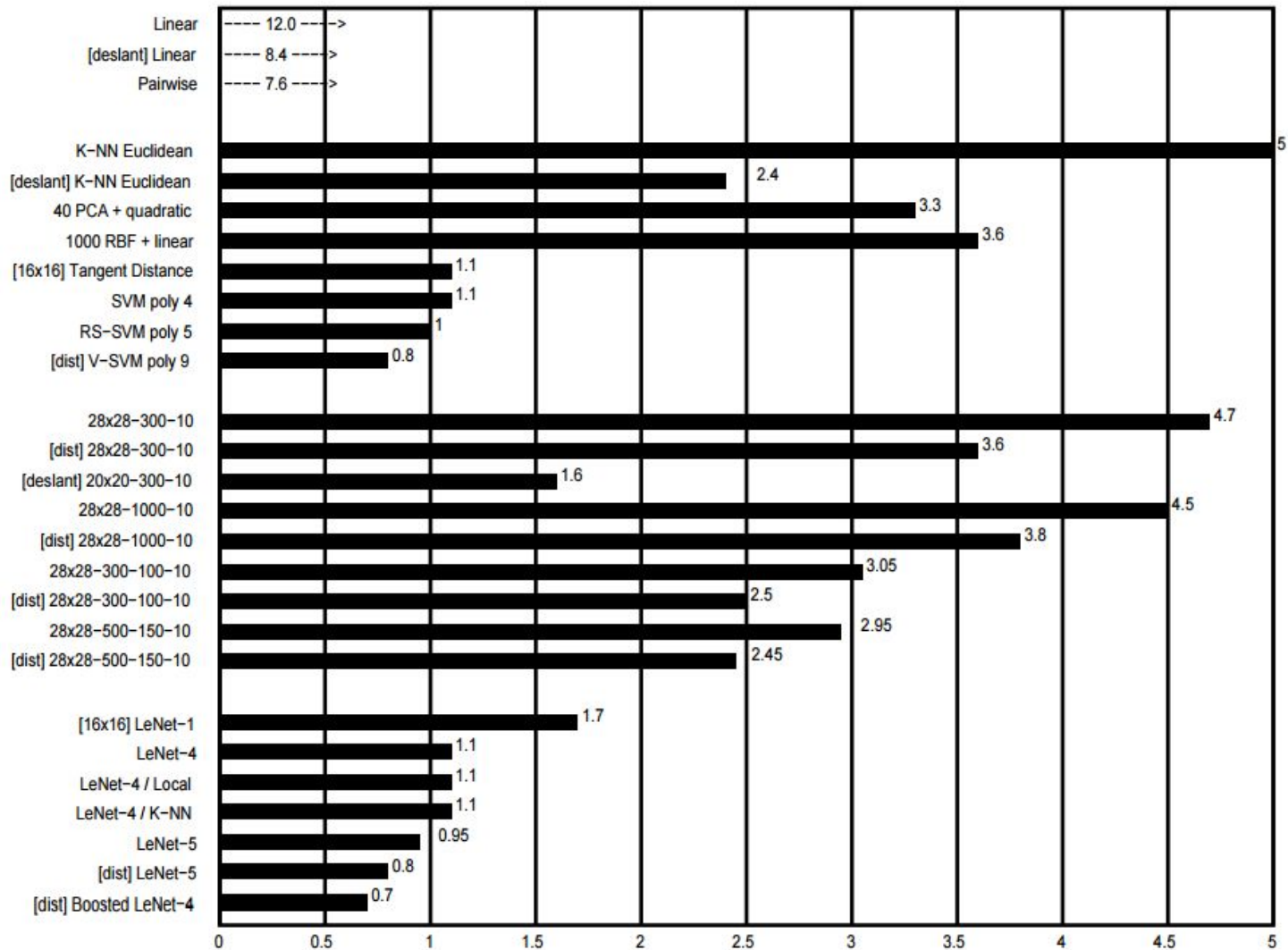

Sparse Autoencoders

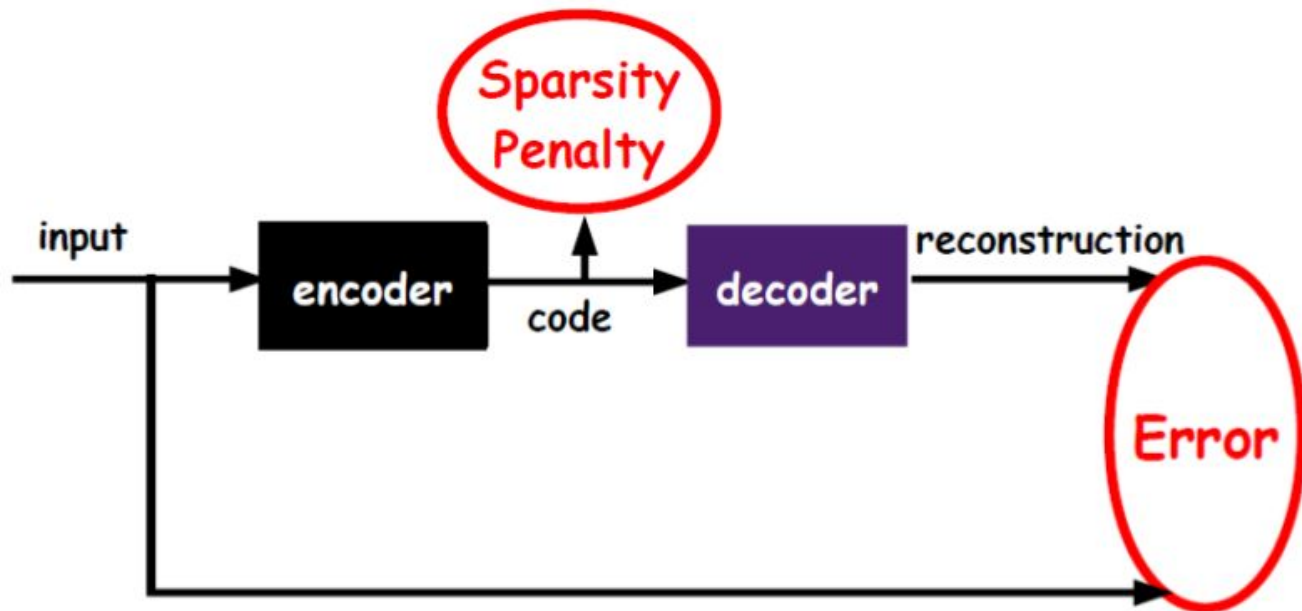

- input: X code: $h = W^T X$

- loss: $L(X; W) = \|W h - X\|^2 + \lambda \sum_j |h_j|$

Eventos

- **2006 - Autoencoders**
 - Redução de Dimensional.
 - Uso de RBM empilhados como um deep auto-encoder
 - i. Treinar RBM usando imagens como saída e entrada

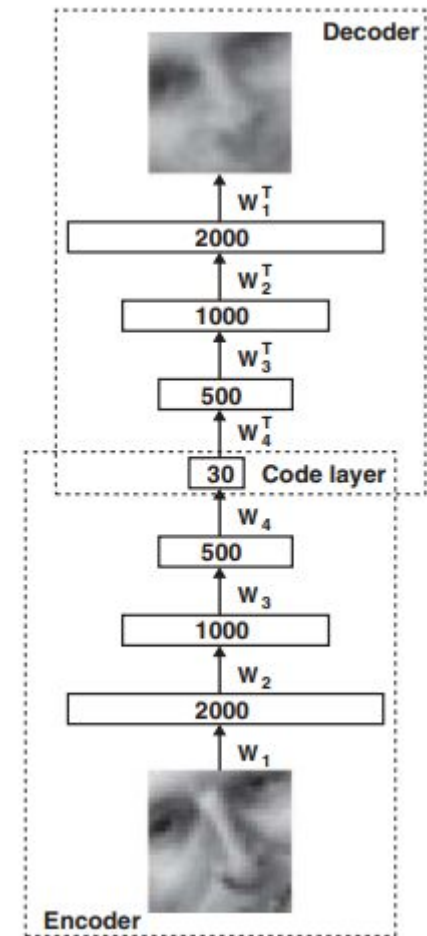

- G. E. [Hinton](#) & R. R. Salakhutdinov. *Reducing the Dimensionality of Data with Neural Networks*, Science 313 (2006), p. 504–507.

Eventos

Olivetti face data, 25x25 pixel images reconstructed from 30 dimensions (625 \rightarrow 30)



- G. E. Hinton & R. R. Salakhutdinov. *Reducing the Dimensionality of Data with Neural Networks*, Science 313 (2006), p. 504–507.

Unsupervised Pre-training

- 1) Dado uma imagem (não rotulada), aprenda características

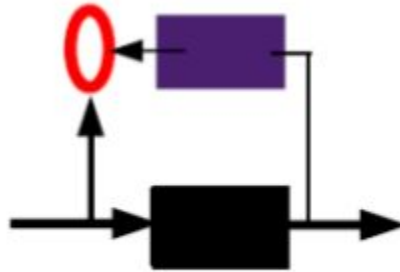

Unsupervised Pre-training

- 1) Dado uma imagem (não rotulada), aprenda características
- 2) Use o encoder para produzir novas features e treinar outra camada

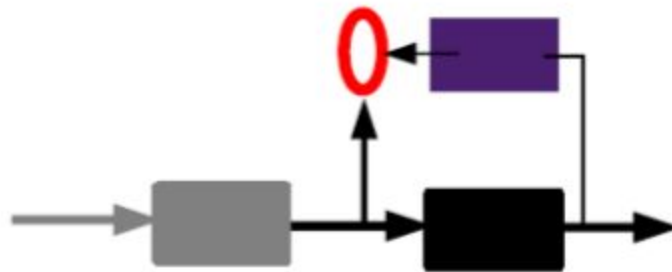

Unsupervised Pre-training

- 1) Dado uma imagem (não rotulada), aprenda características
- 2) Use o *encoder* para produzir novas *features* e treinar outra camada

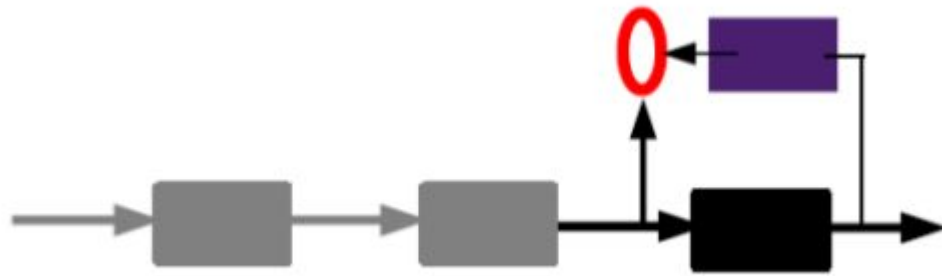

Eventos

- **2006 - Autoencoders**

- PCA vs (784-1000-500-250-2) autoencoder * $28^2 = 784$

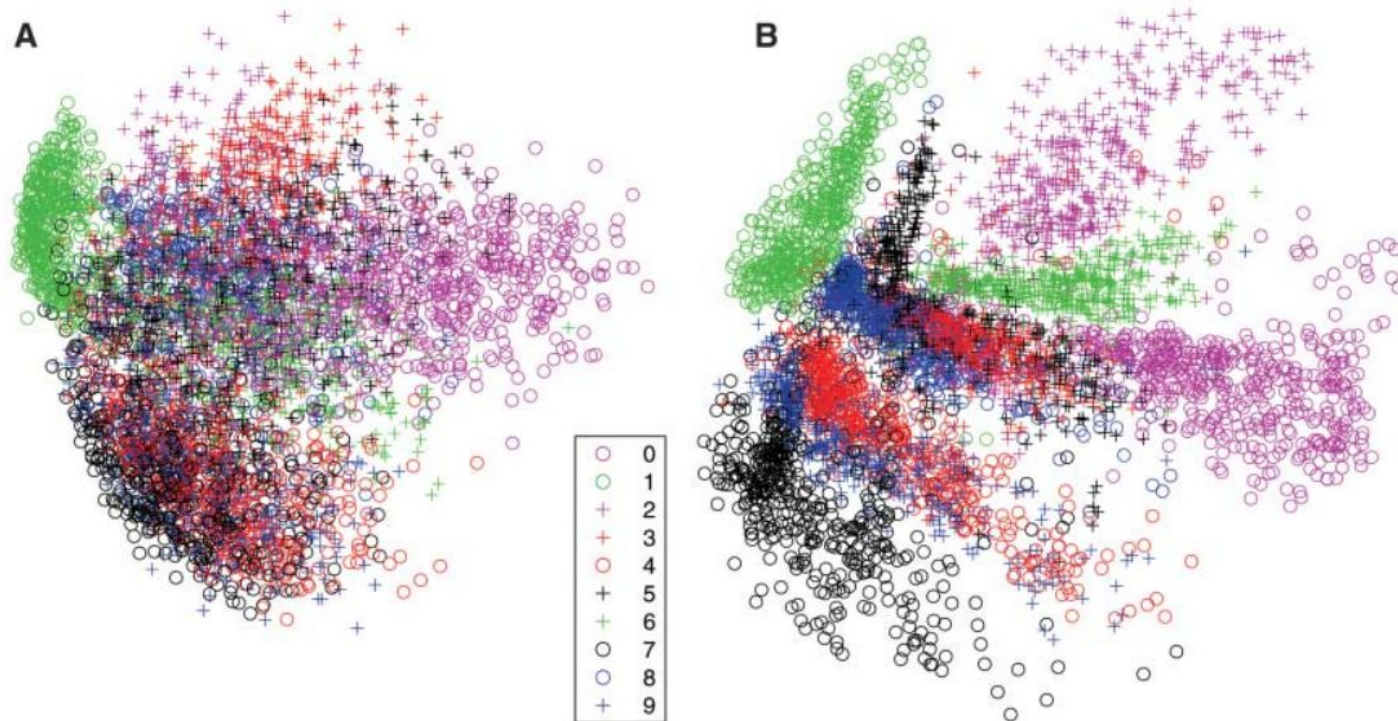

- G. E. Hinton & R. R. Salakhutdinov. *Reducing the Dimensionality of Data with Neural Networks*, Science 313 (2006), p. 504–507.

Eventos

- **2006 - Autoencoders**
 - 804'414 news da Reuters, redução para 2D
 - PCA **vs** 2000-500-250-125-2 autoencoder

PCA

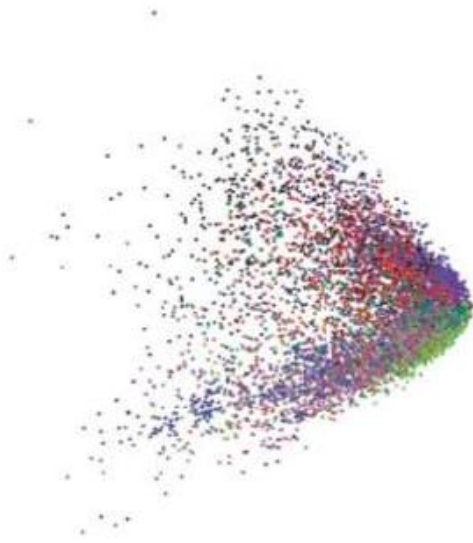

Deep RBN

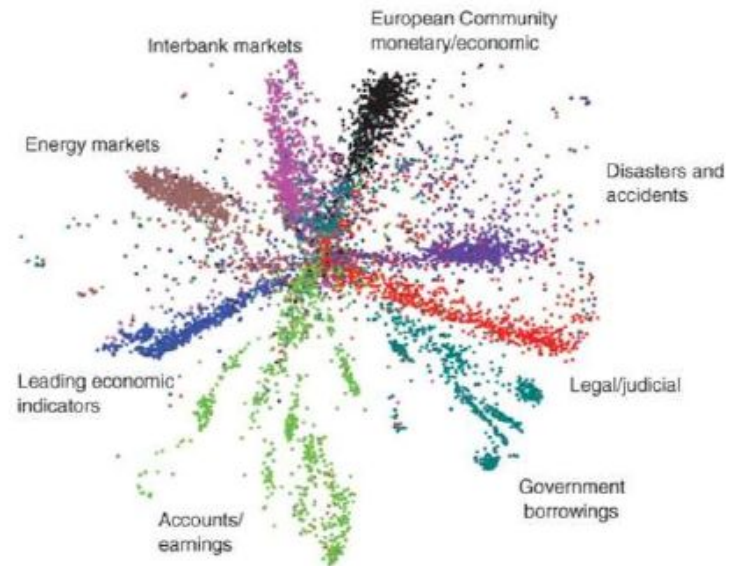

Eventos

- Dados não rotulados estão disponíveis
- Exemplos: Imagens da web
 - a. Baixar 10.000.000 imagens
 - b. Treinar uma DNN 9-camadas
 - c. Conceitos são formados pela DNN



- Q. V. Le, M. Ranzato, R. Monga, M. Devin, K. Chen, G. S. Corrado, J. Dean, A. Ng. Building High-Level Features using Large Scale Unsupervised Learning in ICML 2012 (citado por 1610 Jul/2018)

Eventos

- **Deep Auto-Encoder (Unsupervised) - ImageNet**
 - 10M Images **200x200 pixels** / 20 Classes
 - Cluster (1k CPUs / 16k cores)



- Q. V. Le, M. Ranzato, R. Monga, M. Devin, K. Chen, G. S. Corrado, J. Dean, [A. Ng](#). Building High-Level Features using Large Scale Unsupervised Learning in ICML 2012 (citado por 1610 jul/2018)

Eventos

- **2010 - Google Brain**
 - 1,000 CPUs (16k cores)
 - 600 kWatts
 - U\$ 5.000.000
 - Prédio / Refrigeração

 - *Self-driving cars*
 - *Voice Recognition*

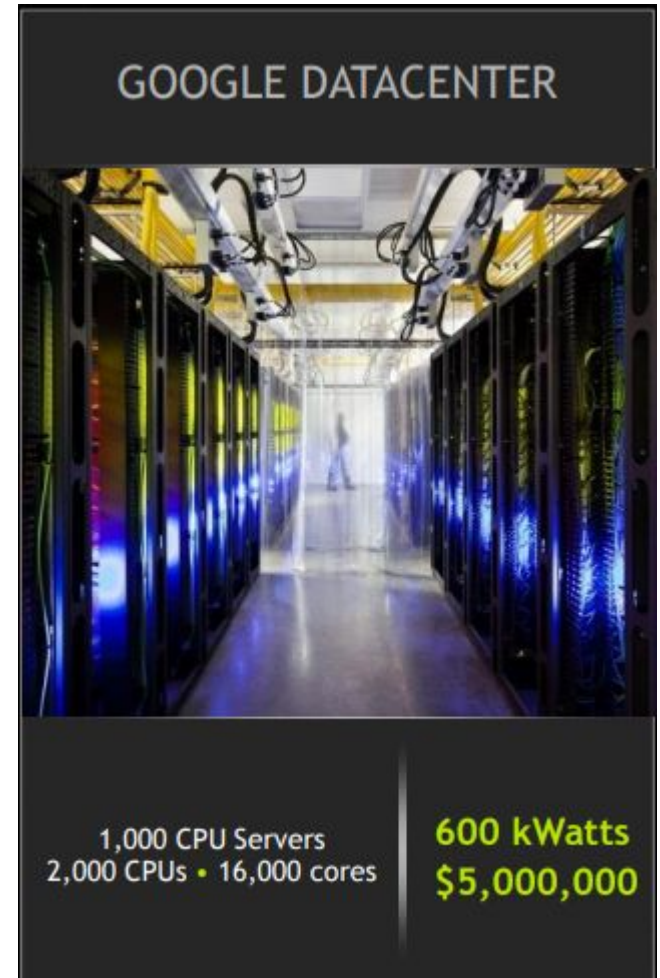

Eventos

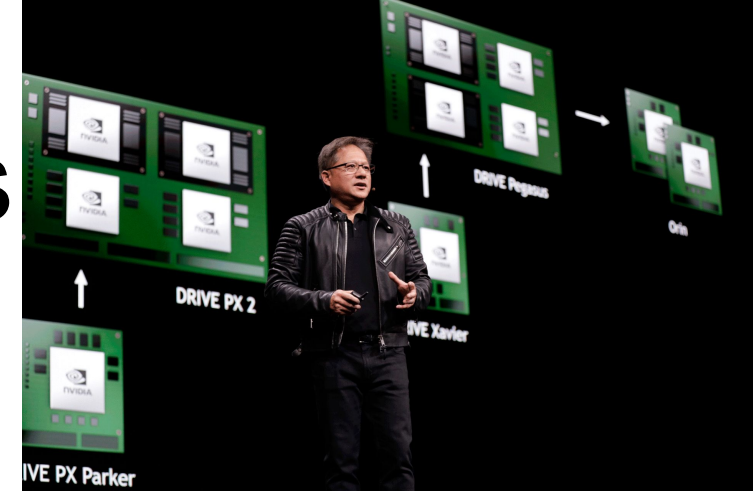

NVIDIA CEO - **Jensen Huang**

- **2013 - NVIDIA**
 - GTC (2014)
 - 3 Servidor (12 GPUs)
 - 18.432 cores
 - 4 KWatts
 - U\$ 33.000
- GPUs 20-50x +CPUs
 - 2010?



- A. Coates, B. Huval, T. Wang, D. Wu, **A. Ng**, B. Catanzaro (421 citações - jul/2018)
Deep learning with COTS HPC systems - Int. Conf Machine Learning (ICML) 2013

Eventos

- **AlexNet (ImageNet) / Cuda-ConvNet**

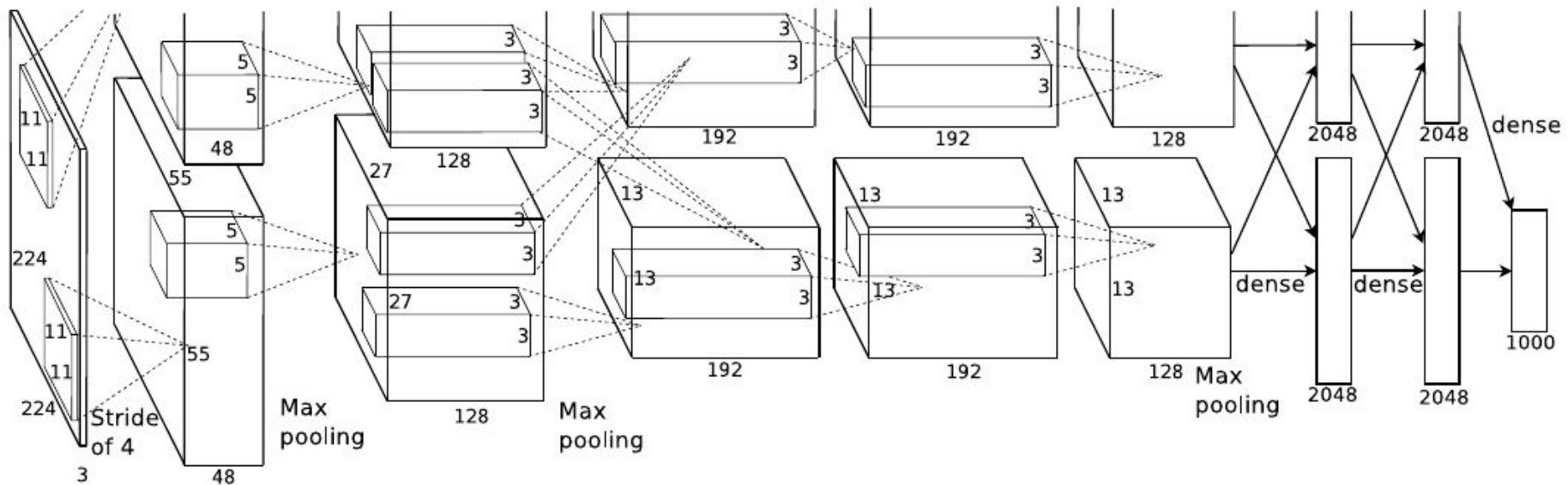

- 60M parametrôs / 650K neurônios
- 3 GPUs - limitado tamanho modelo pela RAM das GPUs
- ImageNet (15M images / 22k classes) - erro caiu para 15%

- A. Kryzhevsky, I. Sutskever, G.E. Hinton. ImageNet Classification with Deep Convolutional Neural Networks. NIPS, 2012. (+26 mil citações jul/2018)

AlexNet (ImageNet)

- **1 Test / 6 Train (menor distância)**

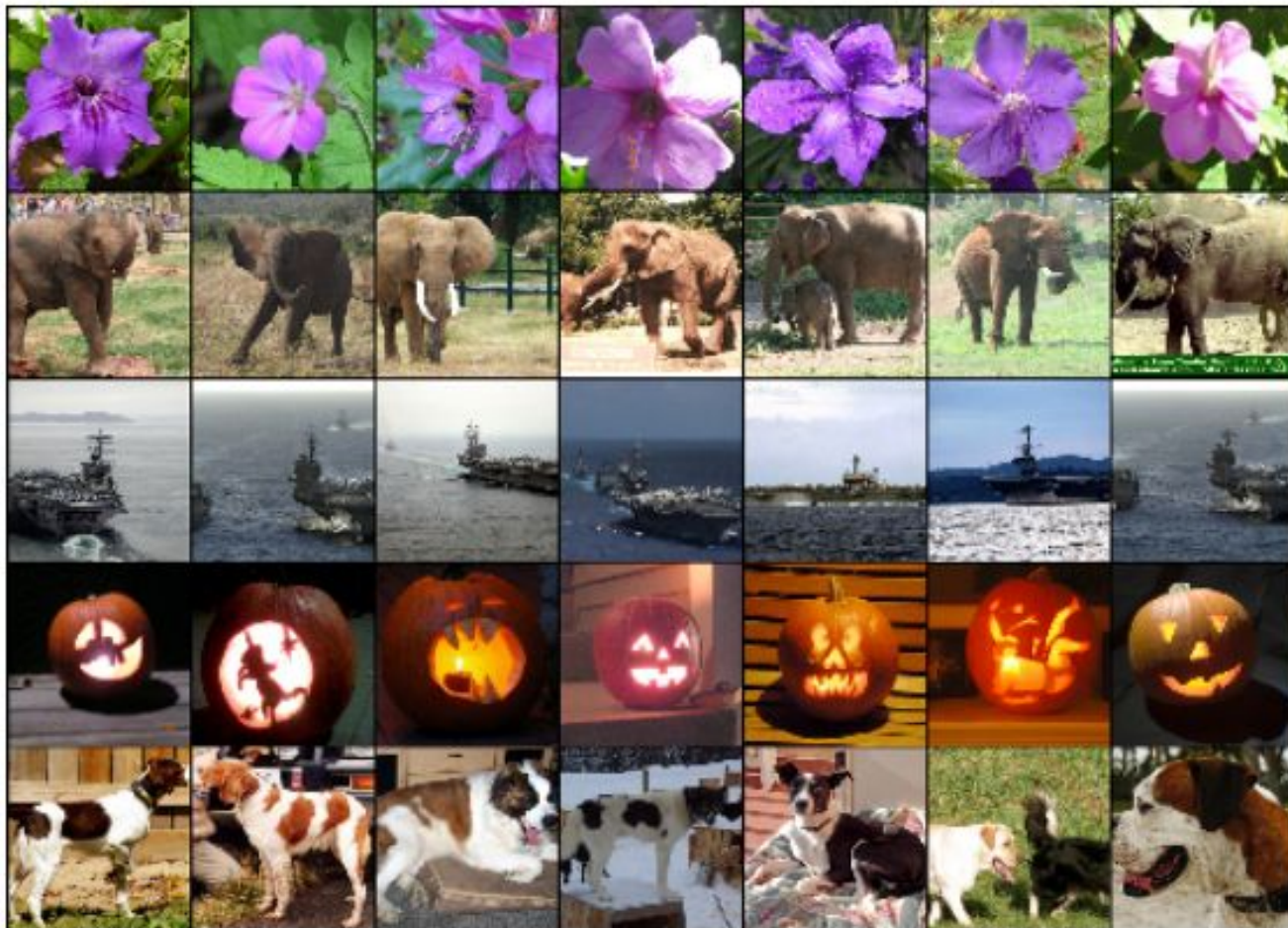

AlexNet (ImageNet)

- Classes *Top 5*



Hierarquia das Representações Treinadas



Características de baixo nível

Características de médio nível

Características de alto nível

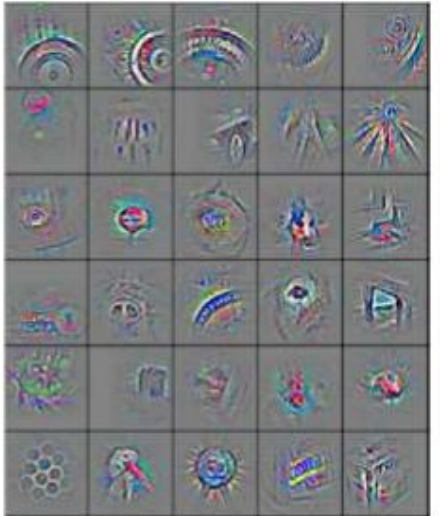
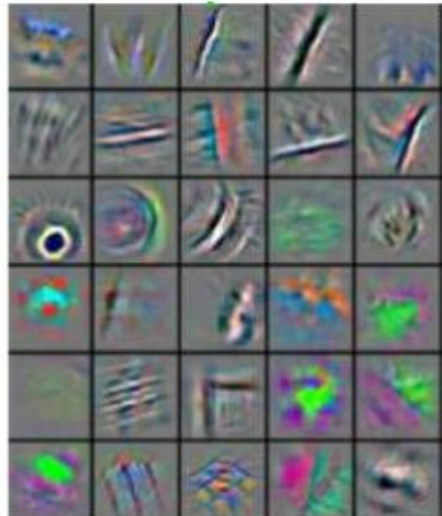

- Zeiler & Fergus. *Visualizing and Understanding Convolutional Networks*. European Conference on Computer Vision, 2014

ImageNet

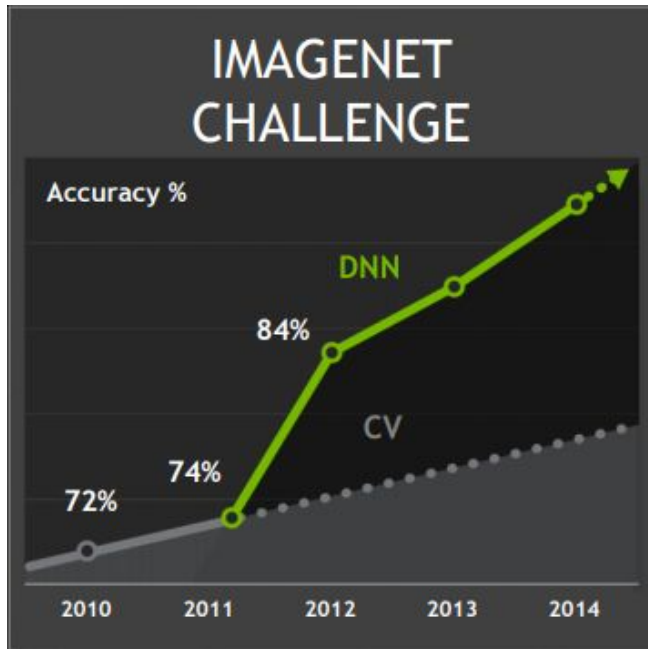

“Deep Image: Scaling up Image Recognition”

– Baidu: 5.98%, Jan. 13, 2015

“Delving Deep into Rectifiers: Surpassing Human-Level Performance on ImageNet Classification”

– Microsoft: 4.94%, Feb. 6, 2015

“Batch Normalization: Accelerating Deep Network Training by Reducing Internal Covariant Shift”

– Google: 4.82%, Feb. 11, 2015

- Larry Brown (Ph.D), Deep Learning with GPUs, GEOINT 2015 - http://www.nvidia.com/content/events/geoInt2015/LBrown_DL.pdf

Eventos

- 2014 - Deep Face (Facebook) / LFW database

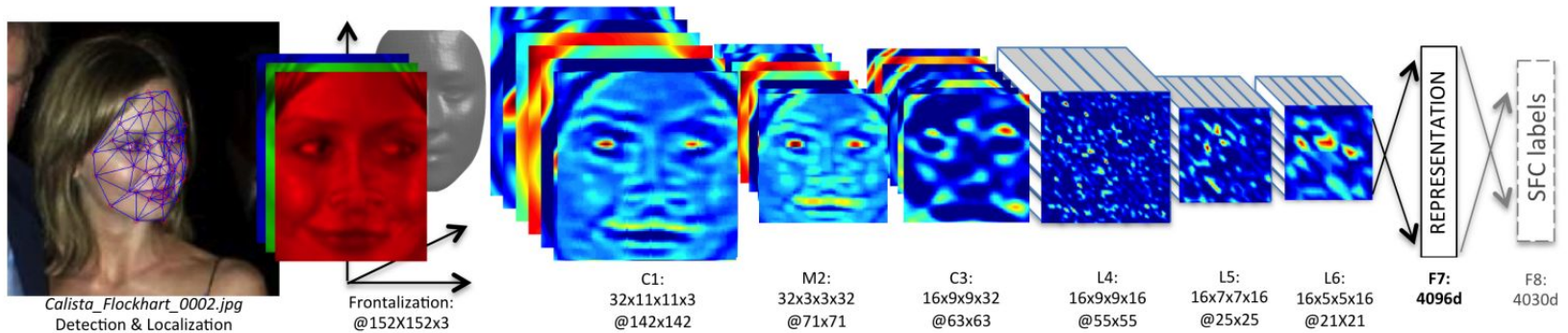

– Treinada com 4M imagens faciais

Modelo	# de parâmetros	Acurácia (%)
Deep Face	128 M	97,35
State-of-the-art [2013]	~	79,70
Nível Humano	N / A	97,50

- Y. Taigman, M. Yang, M.A. Ranzato, L. Wolf. *DeepFace: Closing the Gap to Human-Level Performance in Face Verification*. CVPR 2014.

Eventos

- 2014 - Deep Face (Facebook)
 - Frontalization



(a)



(b)



(c)



(d)



(e)



(f)



(g)



(h)

Eventos

- **2015 - FaceNet (Google-DeepMind2014)**

- Acurácia em 99,63% (LFW)
- Representação Compacta
 - (128 bytes por Face)
- Usaram 100M-200M
 - De 8M de entidades

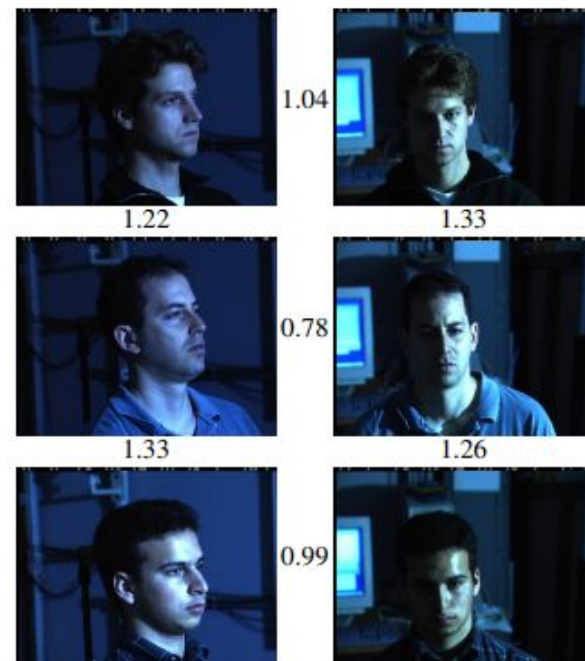
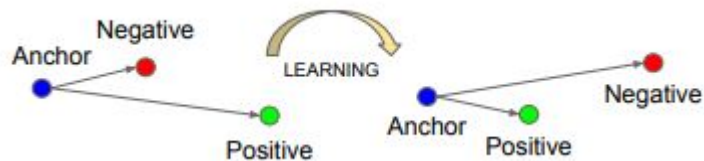

Invariância a iluminação e pose

- F. Schroff, D. Kalenichenko, J. Philbin. FaceNet: A Unified Embedding for Face Recognition and Clustering. CVPR 2015.

2015 - FaceNet - Erros

False accept



- F. Schroff, D. Kalenichenko, J. Philbin. FaceNet: A Unified Embedding for Face Recognition and Clustering. CVPR 2015.

2015 - FaceNet - Erros

" False reject "



- F. Schroff, D. Kalenichenko, J. Philbin. FaceNet: A Unified Embedding for Face Recognition and Clustering. CVPR 2015.

Eventos

- **2010/2013 - TIMIT Phoneme Recognition**

Modelo	# de parâmetros	Erro (%)
Hidden Markov Model (HMM)	N/A	27,3
Deep Belief Network DBN	~4M	26,7
Deep RNN	4,3M	17,7

- Dados:

- Pessoas (#): 462 *train* / 24 *test*
- Tempo (h): 3,16 *train* / 0,14 *test*
- Mohamed, A. and Hinton, G. E. (2010). Phone recognition using restricted Boltzmann machines // ICASSP pages 4354–4357.
- Graves, A., Mohamed, A.-R., and Hinton, G. E. (2013). Speech recognition with deep recurrent neural networks ICASSP, pages 6645–6649.

Eventos

- **2014 - Google Large Vocabulary Speech Recognition**
 - Data de treinamento: 3M expressões (1900 hrs)

Modelo	# de parâmetros	Cross-entropy (%)
ReLU DNN	128 M85M	11,3
Deep Projection LSTM RNN	13M	10,7

- H. Sak, A. Senior, F. Beaufays. Long Short-Term Memory Recurrent Neural Network Architectures for Large Scale Acoustic Modeling // INTERSPEECH'2014.
- K. Vesely, A. Ghoshal, L. Burget, D. Povey. Sequence-discriminative training of deep neural networks // INTERSPEECH'2014.

Inteligência Artificial

- **Processamento de Linguagem Natural (2010)**
 - Siri (Apple)
 - The Assistant (Google)
 - Microsoft (Cortana)
 - Alexa (Amazon)

Eventos

- 2001 - Face Detection - Viola & Jones

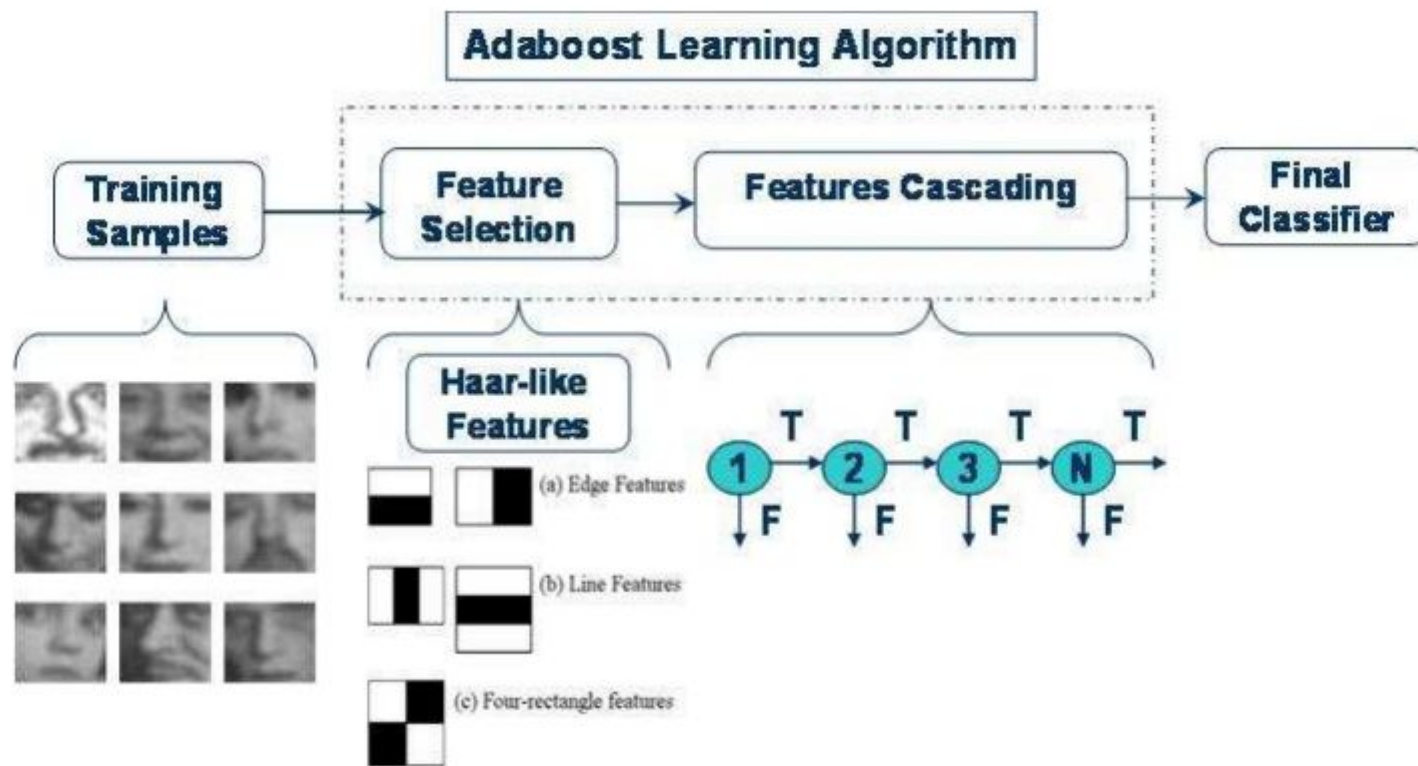

- P. Vila & Jones, Rapid object detection using a boosted cascade of simple features
IEEE Conference on Computer Vision and Pattern Recognition (CVPR) 2001

Eventos

- **2001 - Object Detection - Viola & Jones**

- Semanas para treinar
 - Características simples
- Imagens de 384x288 pixels
- 15 fps 700 Mhz
 - Pentium III
- ~94 de acurácia
- Máquinas Fotogr.

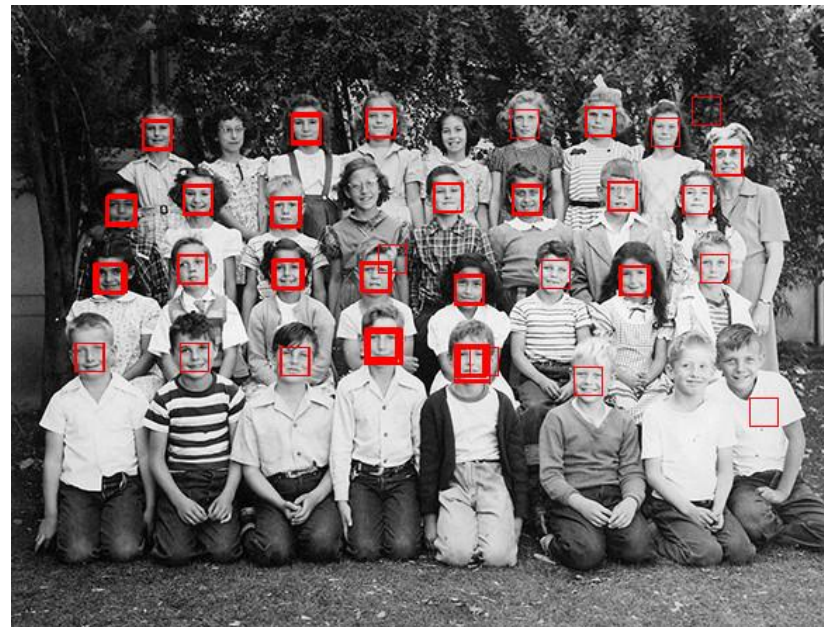
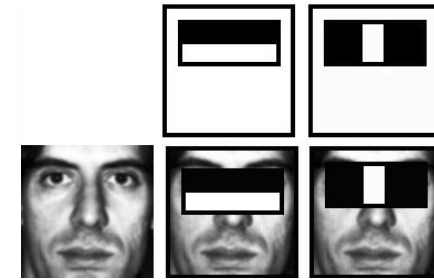

Eventos

- 2015-2017 Yolo (Object Detection)

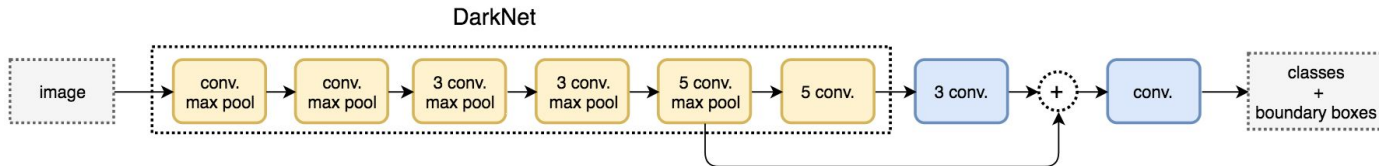
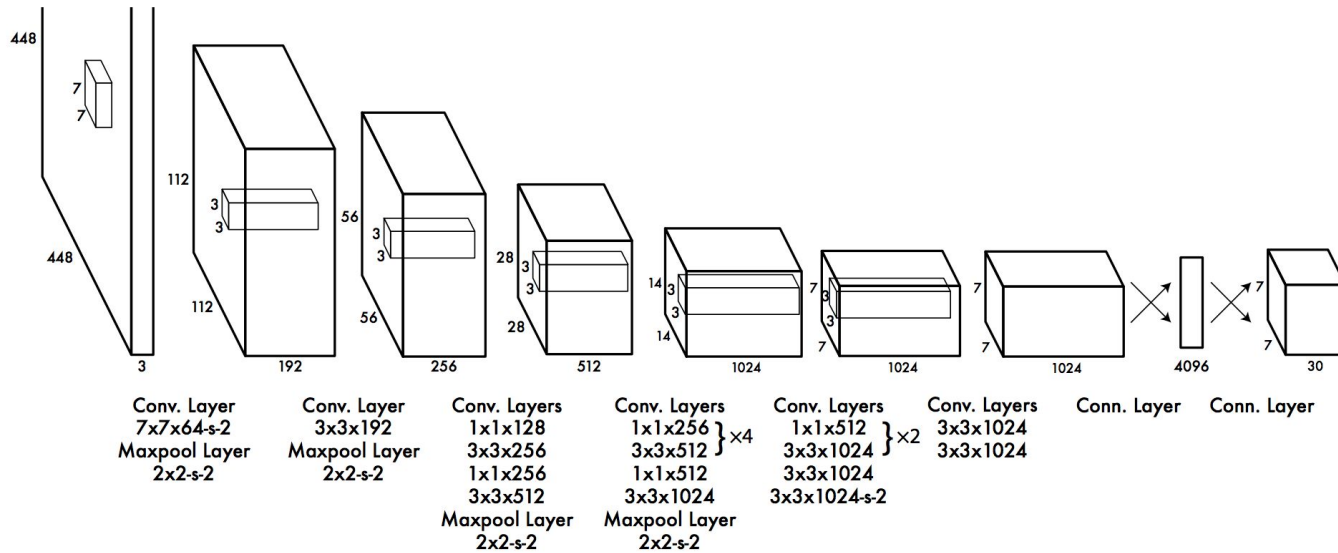

Eventos

- 2015-2017 Yolo (Object Detection)

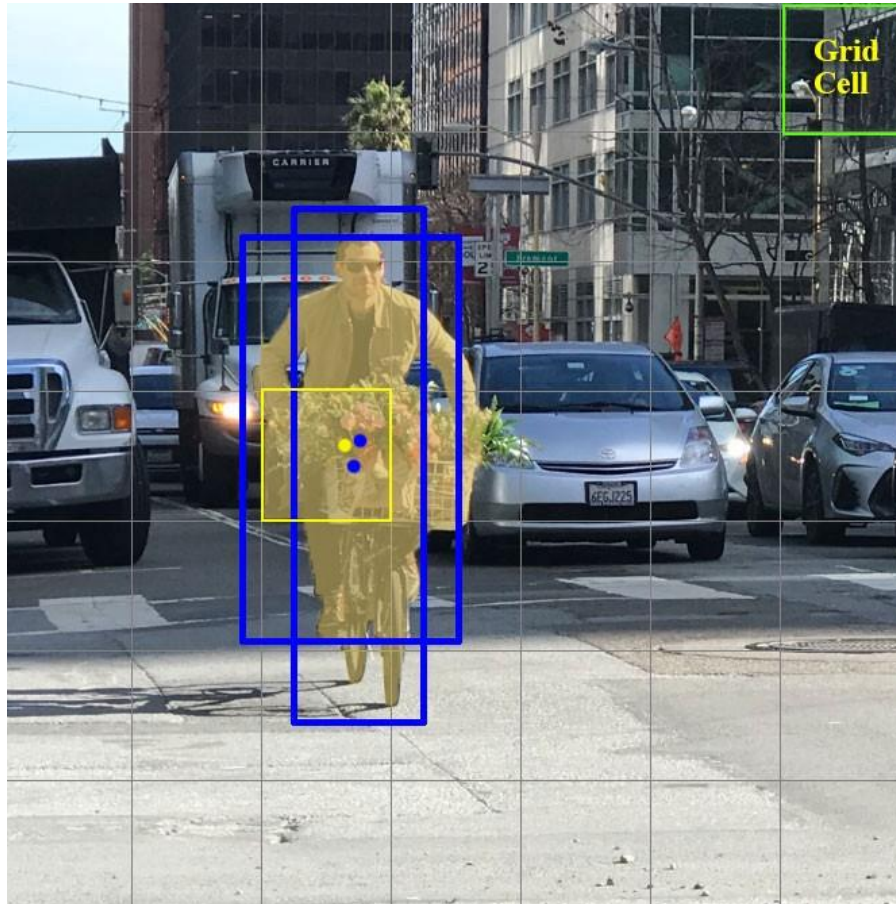

Object Detection

- **Demonstração YoloV2 & YoloV3**
 - **Vídeos ~ 2 minutos**

Eventos

- **2015-2018 Identificação de Veículos**
 - Câmera e Veículo em movimento

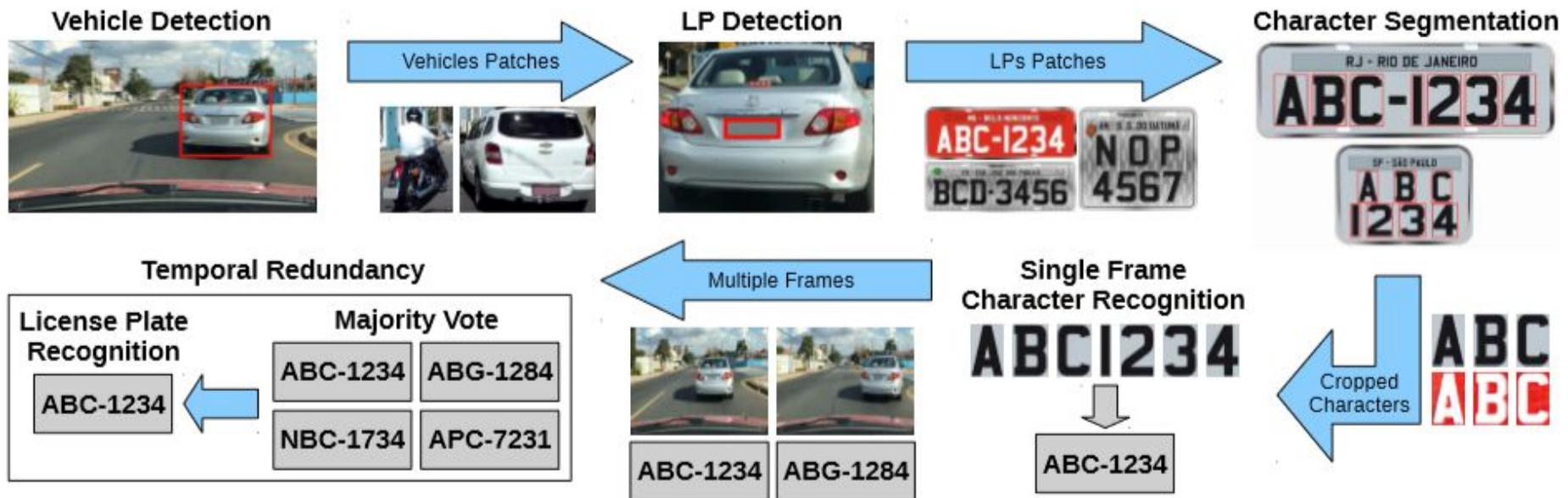
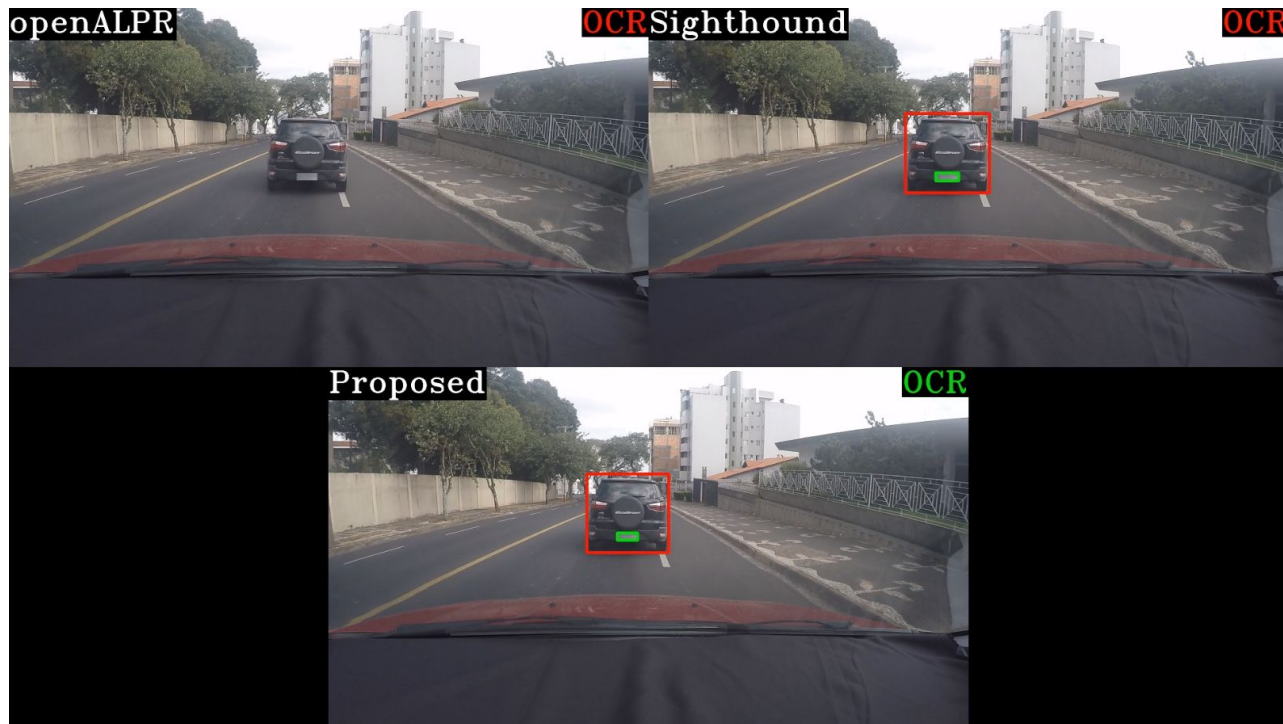

Fig. 5. An usual ALPR pipeline having temporal redundancy at the end.

- R. Laroca, others, D. Menotti, A robust real-time automatic license plate recognition based on the YOLO detector. IEEE International Joint Conference on Neural Networks (IJCNN) 2018.

Eventos

- **2015-2018 Identificação de Veículos**
 - Vídeo



- R. Laroca, others, D. Menotti, A robust real-time automatic license plate recognition based on the YOLO detector. IEEE International Joint Conference on Neural Networks (IJCNN) 2018.

Eventos

- 2018 Retificação da Placa

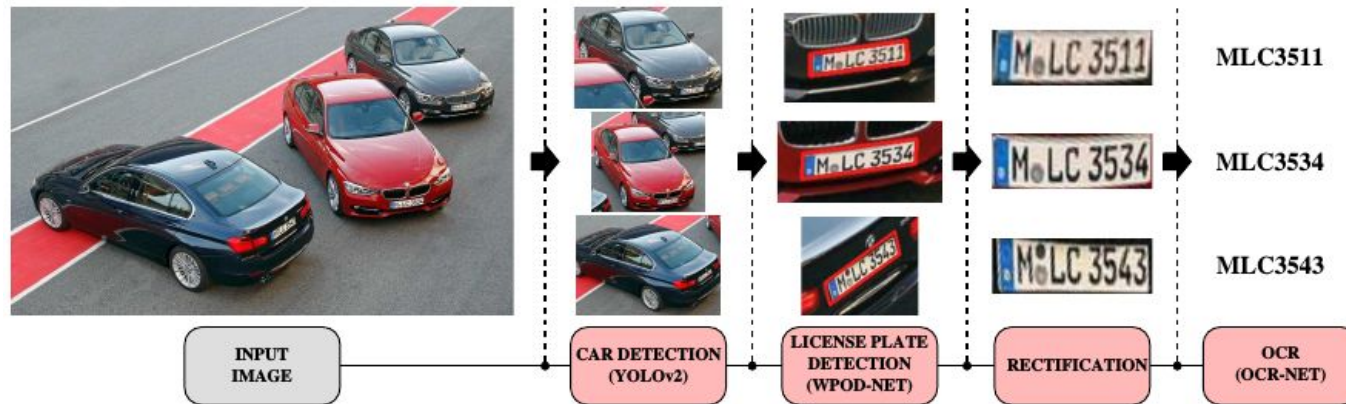
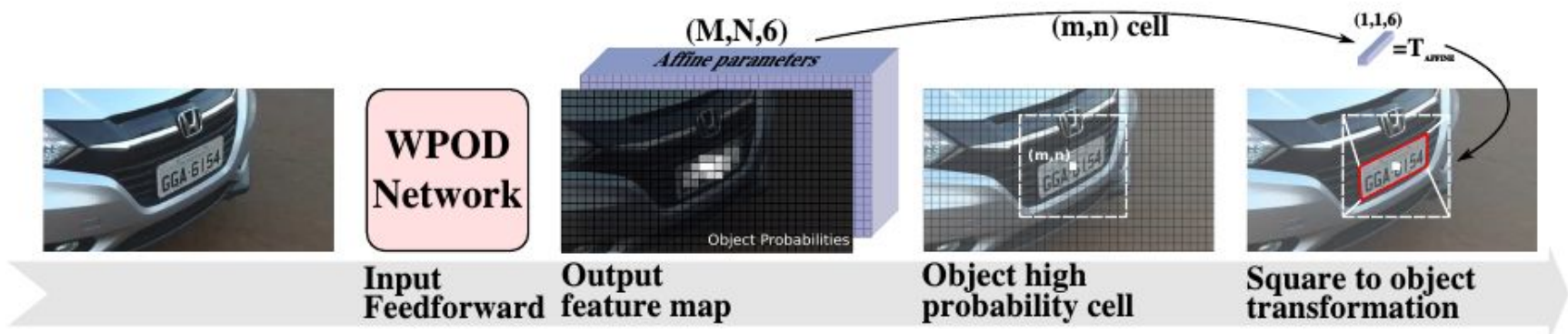

- S. Montazolli & C. R. Jung, License Plate Detection and Recognition in Unconstrained Scenarios. European Conference on Computer Vision (ECCV) 2018.

Eventos

- **2018 Identificação de Veículos**

- Vídeo

- <http://www.inf.ufrgs.br/~crjung/alpr-datasets/>



- S. Montazolli & C. R. Jung, A robust real-time automatic license plate recognition based on the YOLO detector. IEEE International Joint Conference on Neural Networks (IJCNN) 2018.

Eventos

- **2016 - AlphaGo (Image)**
 - Usa conhecimento humano & experiência
 - DL vence por 4 a 1 **Lee Sedol** (echo de **Garry Kasparov**)
 - Jogo muito mais complexo que xadrez
 - Google usou 1920 CPUs & 280 GPUs



Eventos

- **2017 - AlphaGo Zero (*Reinforcement learning*)**
 - Conhece regras do jogo / sem usar dados de treinamento
 - Aprende jogando contra si mesmo,
 - Venceu AlphaGo Lee (3 dias), competitivo com AlphaGo Master (21 dias) e superou todos com 40 dias
 - 19 servidores CPU e 64 estações GPU
 - Melhor que ser humano sem conhecimento
 - **Implicações?**



- [Silver, David](#); Schrittwieser, Julian; Simonyan, Karen; Antonoglou, Ioannis; [Huang, Aja](#); Guez, Arthur; Hubert, Thomas; Baker, Lucas; Lai, Matthew; Bolton, Adrian; [Chen, Yutian](#); Lillicrap, Timothy; [Fan, Hui](#); Sifre, Laurent; Driessche, George van den; Graepel, Thore; [Hassabis, Demis](#) (19 October 2017). "[Mastering the game of Go without human knowledge](#)". *Nature*. **550** (7676): 354–359

Bigshots - Machine Learning

- **Geoffrey Hinton (University of Montreal)**
 - Nature em 1986
 - Backpropagation
 - Science em 2006
 - Stacker Auto-encoder
 - redução de dimensionalidade
 - Explorou ImageNet 2012
 - Lecun & Bengio

Bigshots - Machine Learning

- **Yoshua Bengio - University of Montreal**
 - Trabalhos teóricos (*insights*)
 - Continua fazendo pesquisa
 - Irmão está na Google (Sammy Bengio)
 - Hinton & Bengio

Bigshots - Machine Learning

- **Yann Lecun - Facebook / NYU**
 - “Pai” da Rede de Convolução
 - 1989 Trabalho de graduação (ESIEE-Paris)
 - 1998 - Convolução para Back-propagation
 - 1991 PostDoc (University of Toronto)
 - Hinton
 - 1996 AT&T Labs - Image Processing Head
 - 2003 NYU (*New York University*)
 - 2013 - Chief AI Scientist for Facebook AI Rs
 - Hinton & Bengio

Bigshots - Machine Learning

- **Jurgen Schmidhuber (Switzerland)**
 - (Re)Clama / Questiona autorias
 - 2012 - Reconhecedor de Placas de Trânsito
Acurácia superior a de seres humanos (99,36%/98,48%)

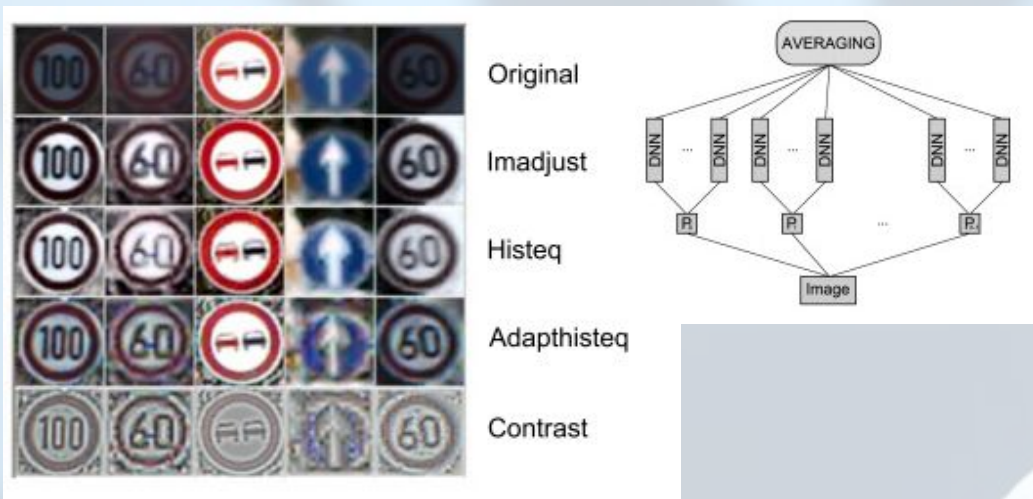

- D. Cireşan, U. Meier, J. Masci, **Jürgen Schmidhuber**. Multi-column deep neural network for traffic sign classification, Neural Networks, 2012 (citado por 468 jul/2018)

Bigshots - Machine Learning

- **Andrew NG - (Stanford University)**
 - Aprendizado não-supervisionado dos pesos
 - Clusters (k-means) originam pesos
 - O próximo *breakthrough* está aqui ???
 - Excelente curso MOOC

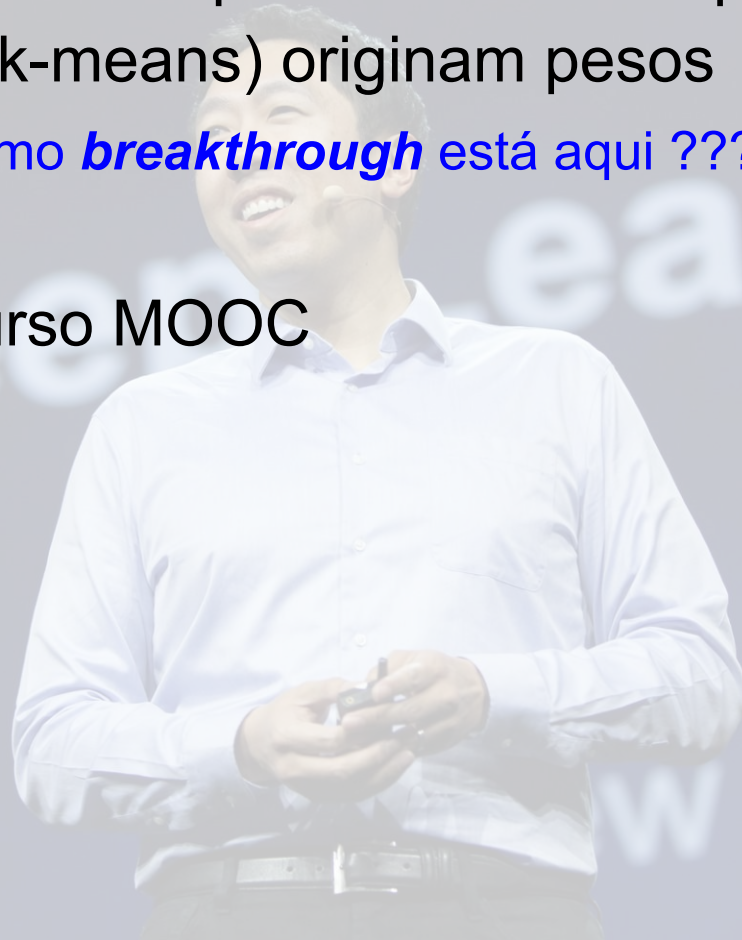

Bigshots - Machine Learning

- **David Cox - Harvard / MIT**
 - Redes Imitam Cérebro
 - Experimentos com ratos
 - Não há aprendizado de pesos, mas sim otimização da arquitetura
 - Tamanhos das camadas da Rede relacionadas a estrutura cerebral
 - Pesos com Padrão (Média Zero e Norma Unitária)
 - **Nicolas Pinto** - Alta-performance (GPU)

Bigshots - Machine Learning

- **David Cox - Harvard / MIT**
 - Cérebro & Redes de Convolução

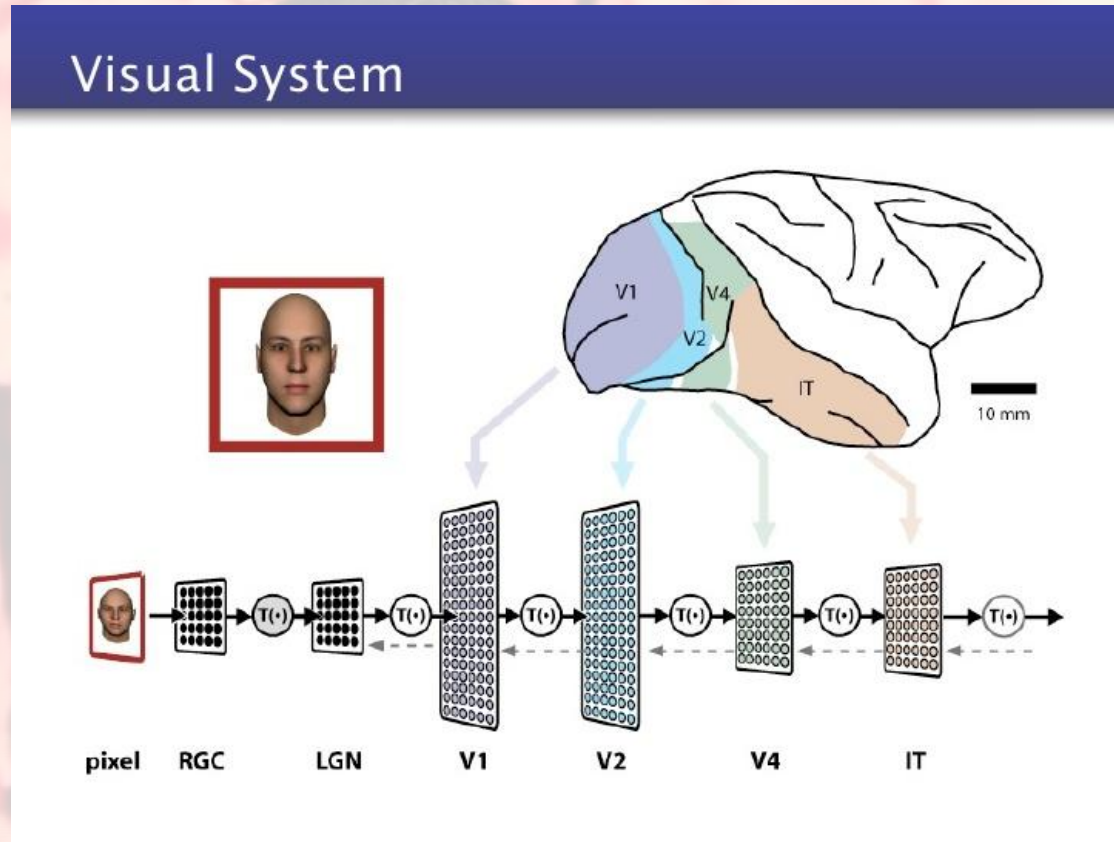



Referências

- James O'Malley **The 10 most important breakthroughs in Artificial Intelligence**
<https://www.techradar.com/news/the-10-most-important-breakthroughs-in-artificial-intelligence>
- Seth Weidman **The 4 Deep Learning Breakthroughs You Should Know About**
<https://towardsdatascience.com/the-5-deep-learning-breakthroughs-you-should-know-about-df27674ccdf2>
- Artem Chernodub, Geroge Pashchenko, **Details of Lazy Deep Learning for Images Recognition in ZZ Photo app**, Kharkob AI Club, 2015
- Alex Oagana **A Short History of Mercedes-Benz Autonomous Driving Technology**
<https://www.autoevolution.com/news/a-short-history-of-mercedes-benz-autonomous-driving-technology-68148.html>